

CAD DRAWING - NO MANUAL REVISIONS

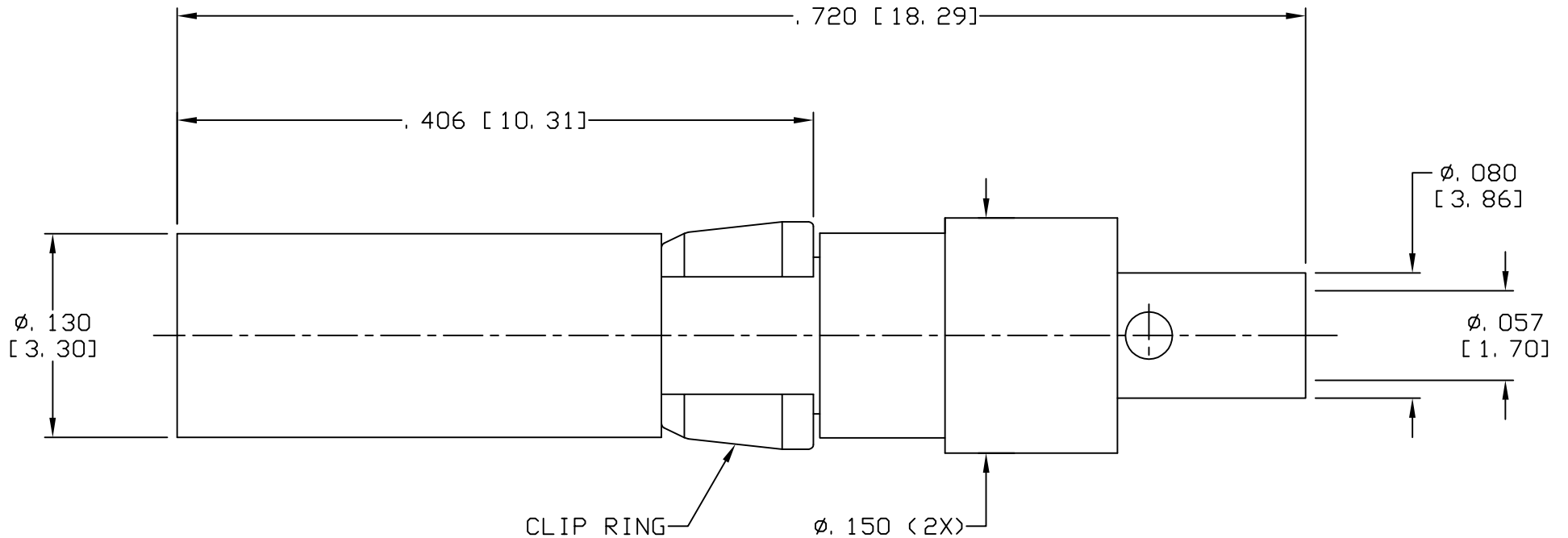

NOTES:

1. DESIGN AND INTERFACE PER IDS-56A.
2. ACCOMMODATES RG-178 OR EQUIVALENT CABLES.
3. FOR USE IN BENDIX LRM OR SIZE 12 D-SUB HOUSINGS.
4. "J" PLATING TEST TO 20 GAMMA MAX.
5. CONTACT SHIPPED LOOSE.

D	PER ECN 11730	07/22/13	JEM	PALCO CONNECTOR 22 GREAT HILL RD., NAUGATUCK, CT 06770 UNLESS OTHERWISE SPECIFIED, PALCO WORKMANSHIP STANDARDS APPLY TOLERANCES ON: DECIMALS: XX ± .01 .XXX ± .005 ANGLES ±1/2° 32' DIMENSIONS IN INCHES OR (METRIC) DO NOT SCALE PRINTS	DRAWN JEM	CHECKED JEM	ENGINEER JEM	APPROVED JEM	FSCM 58167
C	PER ECN 11648	04/22/13	JEM			DESCRIPTION SIZE 12 PKZ RECEPTACLE, DIRECT SOLDER			
B	PER ECN 11606	02/26/13	JEM			DATE 11/02/12	DRAWING NO. 56-1202-0400	PLATING OPT. J	
A	PER ECN 11534	01/07/13	JEM		CATALOG ITEM				
01	PROTOTYPE	11/02/12	JEM						
REV.	DESCRIPTION	DATE	APPR.						

CABLE ASSEMBLY PROCEDURE		 22 GREAT HILL ROAD, NAUGATUCK, CT. 06770 PHONE: (203) 729-9090 FAX: (203) 723-1794	REV	DESCRIPTION	DATE	APPR
P/N	56-1202-0400		A	PER ECN 11534	01/07/13	JEM
PAGE 1 OF 1	DATE: 11/07/12		B	PER ECN 11606	02/26/13	JEM
DRAWN: JEM	APPROVED: JEM		C	PER ECN 11648	04/22/13	JEM
FOR USE WITH RG-178 CABLE			D	PER ECN 11730	07/22/13	JEM

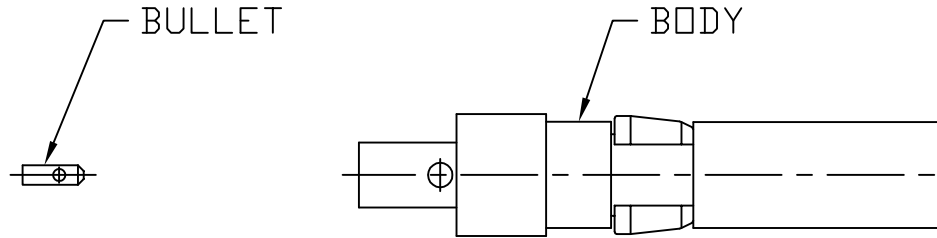

STEP 1
 DIP END OF CABLE INTO FLEX AND THEN TIP DIP CABLE TO DIMENSIONS SHOWN USING KESTER 63/37 SOLDER @ 500°F FOR SIX SECONDS MAX.

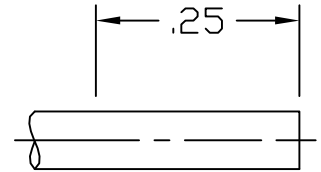

STEP 2
 TRIM CABLE TO DIMENSIONS SHOWN. TIN CENTER CONDUCTOR.

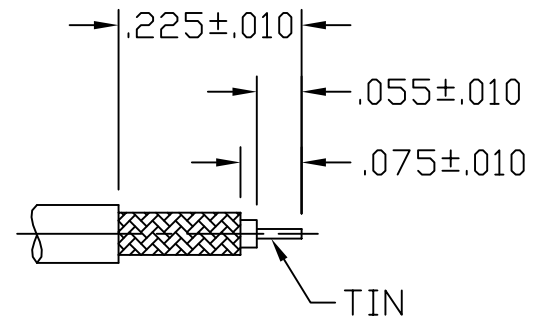

STEP 3
 SLIDE BULLET ONTO CENTER CONDUCTOR AS SHOWN. SOLDER BULLET TO CENTER CONDUCTOR. CLEAN SOLDER JOINT.

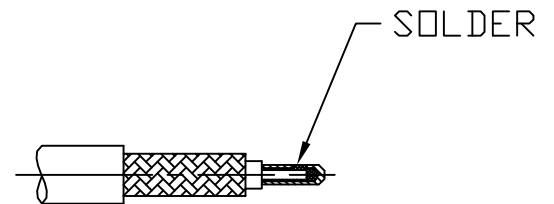

STEP 4
 INSERT ABOVE CABLE INTO CONNECTOR BODY UNTIL CABLE BOTTOMS. SOLDER BODY TO CABLE. CLEAN SOLDER JOINT.

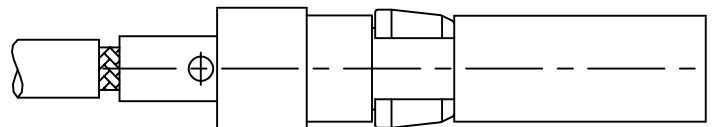

4

3

2

1

SPECIFICATIONS:

1.) MATERIALS:
 INSERTS: VALOX, TYPE GPT-30F, PER MIL-M-24519.
 SHELLS: COLD ROLLED STEEL, PER ASTM A568 AND ASTM A620.

2.) FINISHES AND COLOR:
 INSERT: BLACK.
 SHELLS: RoHS COMPLIANT, HIGH RESISTANCE CLEAR CHROMATE OVER ZINC, PER ASTM B633, CLASS FE/ZN12 (.000500 MIN.), SERVICE CONDITION SC3, TYPE III.

3.) ELECTRICAL PROPERTIES:
 DIELECTRIC STRENGTH:
 500 TO 1,000 VOLTS RMS AT SEA LEVEL;
 200 TO 325 VOLTS RMS AT 70,000 FEET.
 INSULATION RESISTANCE: 1 MEGOHM MINIMUM.

4.) MECHANICAL PROPERTIES:
 OPERATING TEMPERATURE: -67° F TO +257° F (-55° C TO +125° C).
 SHOCK RESISTANCE: NO INTERRUPTION OF ELECTRICAL CONTINUITY LONGER THAN 1 MICROSECOND.
 VIBRATION RESISTANCE: NO INTERRUPTION OF ELECTRICAL CONTINUITY LONGER THAN 1 MICROSECOND.

5.) DIMENSIONS ARE FOR REFERENCE ONLY, UNLESS OTHERWISE SPECIFIED.

6.) CONNECTOR MEETS REQUIREMENTS OF MIL-C-24308, LATEST REVISION.

7.) ABOVE REQUIREMENTS DO NOT INCLUDE PDM AND PKZ CONTACTS, PLEASE SEE INDIVIDUAL SPECIFICATION SHEETS.

8.) METRIC DIMENSIONS ARE SHOWN FOR REFERENCE, CONNECTORS ARE DESIGNED IN INCHES.

REV	DESCRIPTION	DATE	APPROVAL
A	ECN#11740 RELEASED FOR PRODUCTION	7/26/2013	

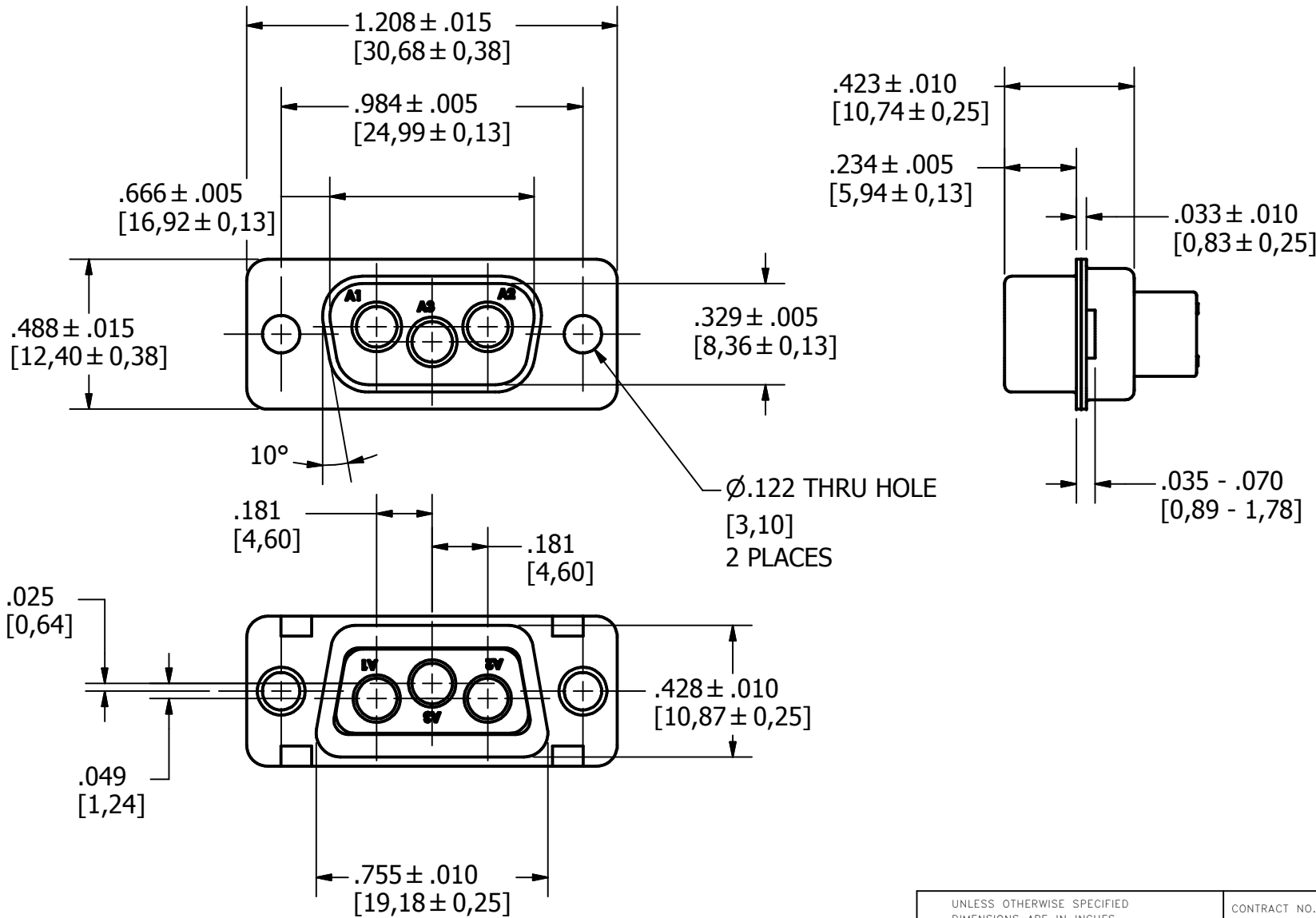

UNLESS OTHERWISE SPECIFIED
 DIMENSIONS ARE IN INCHES
 TOLERANCES ARE:
 FRACTIONS DECIMALS ANGLES
 $\pm 1/64$.XX ± .01 $\pm 1/2^\circ$
 .XXX ± .003

THE INFORMATION DISCLOSED IN
 THIS DOCUMENT IS CONFIDENTIAL
 AND PROPRIETARY TO PHOENIX CO.
 INC. AND MAY NOT BE USED FOR
 MANUFACTURE OR ANY OTHER
 PURPOSE WITHOUT THE WRITTEN
 CONSENT OF MIL-CON INC.

NEXT ASSEMBLY	USED ON

CONTRACT NO.		<i>The PHOENIX Company of Chicago™</i> HD, D-SUB CONNECTOR, SIZE 12 PTRP3W35, PLUG, CLRCROM / ZINC	
APPROVALS	DATE		
DRAWN R.M. Bradley	4/25/2013	SIZE B	FSCM NO. 60563
CHECKED		DWG. NO. PTRP3W35	REV. A
ISSUED		SCALE 2 X1	SHEET 1 OF 1

4

3

2

1

SPECIFICATIONS:

1.) **MATERIALS:**
 INSERTS: VALOX, TYPE GPT-30F, PER MIL-M-24519.
 SHELLS: COLD ROLLED STEEL, PER ASTM A568 AND ASTM A620.

2.) **FINISHES AND COLOR:**
 INSERT: BLACK.
 SHELLS: RoHS COMPLIANT, HIGH RESISTANCE CLEAR CHROMATE OVER ZINC, PER ASTM B633, CLASS FE/ZN12 (.000500 MIN.), SERVICE CONDITION SC3, TYPE III.

3.) **ELECTRICAL PROPERTIES:**
 DIELECTRIC STRENGTH:
 500 TO 1,000 VOLTS RMS AT SEA LEVEL;
 200 TO 325 VOLTS RMS AT 70,000 FEET.
 INSULATION RESISTANCE: 1 MEGOHM MINIMUM.

4.) **MECHANICAL PROPERTIES:**
 OPERATING TEMPERATURE: -67° F TO +257° F (-55° C TO +125° C).
 SHOCK RESISTANCE: NO INTERRUPTION OF ELECTRICAL CONTINUITY LONGER THAN 1 MICROSECOND.
 VIBRATION RESISTANCE: NO INTERRUPTION OF ELECTRICAL CONTINUITY LONGER THAN 1 MICROSECOND.

5.) DIMENSIONS ARE FOR REFERENCE ONLY, UNLESS OTHERWISE SPECIFIED.

6.) CONNECTOR MEETS REQUIREMENTS OF MIL-C-24308, LATEST REVISION.

7.) ABOVE REQUIREMENTS DO NOT INCLUDE PDM AND PKZ CONTACTS, PLEASE SEE INDIVIDUAL SPECIFICATION SHEETS.

8.) METRIC DIMENSIONS ARE SHOWN FOR REFERENCE, CONNECTORS ARE DESIGNED IN INCHES.

REV	DESCRIPTION	DATE	APPROVAL
A	ECN#11740 RELEASED FOR PRODUCTION	7/26/2013	

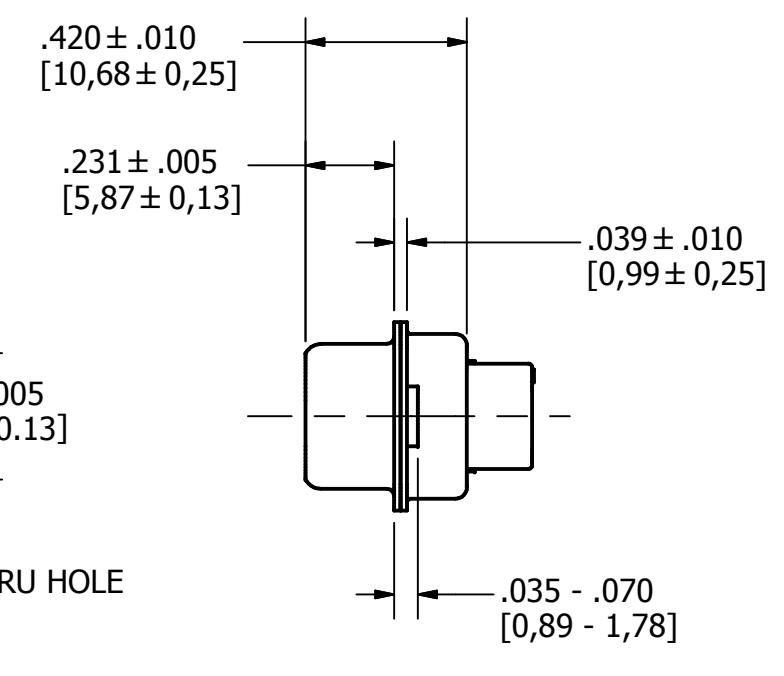
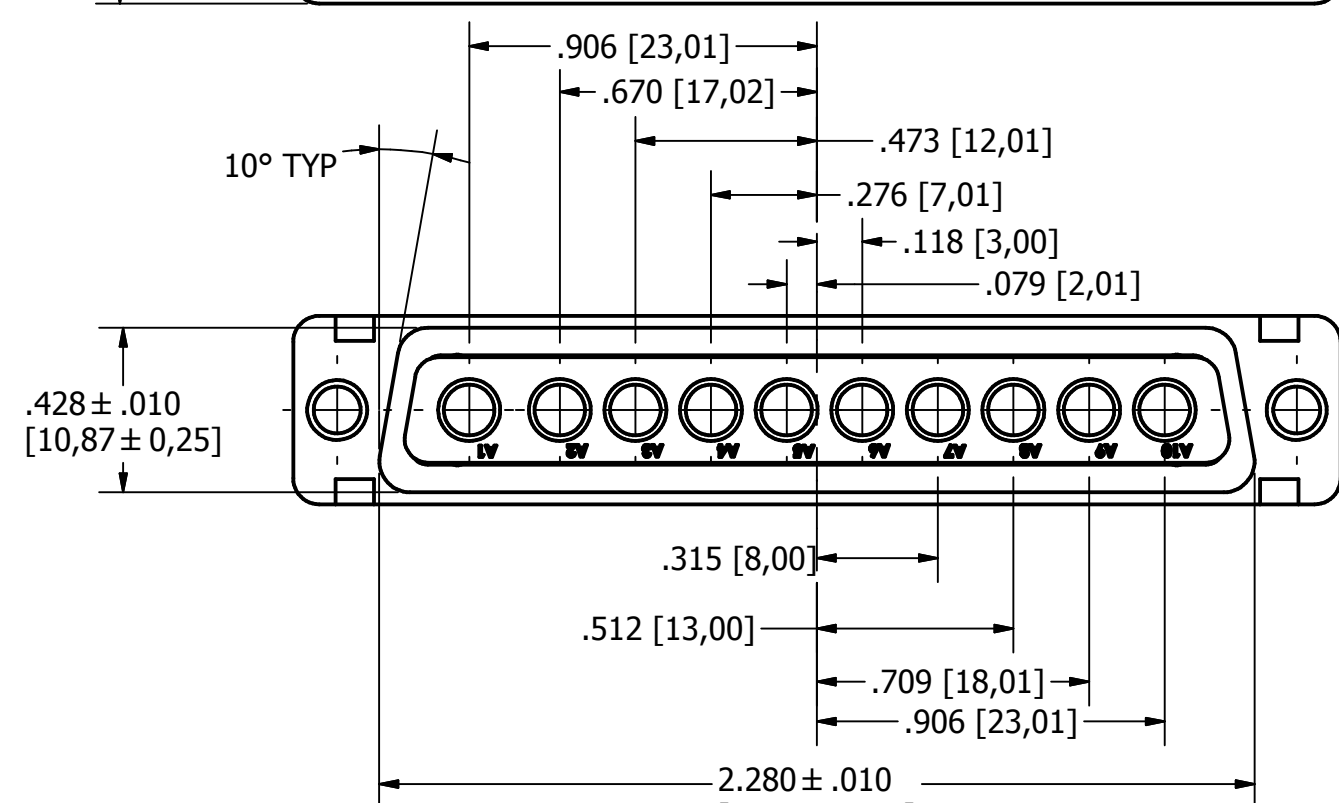
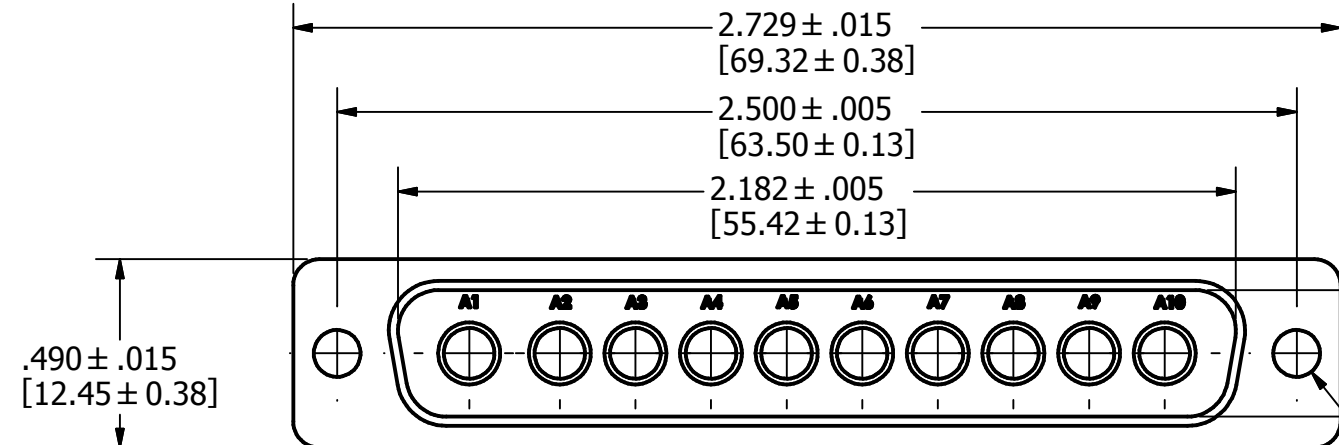

UNLESS OTHERWISE SPECIFIED DIMENSIONS ARE IN INCHES TOLERANCES ARE: FRACTIONS DECIMALS ANGLES $\pm 1/64$.XX ± .01 $\pm 1/2'$.XXX ± .003		CONTRACT NO.		The <i>PHOENIX</i> Company of Chicago™	
THE INFORMATION DISCLOSED IN THIS DOCUMENT IS CONFIDENTIAL AND PROPRIETARY TO PHOENIX CO. INC. AND MAY NOT BE USED FOR MANUFACTURE OR ANY OTHER PURPOSE WITHOUT THE WRITTEN CONSENT OF MIL-CON INC.		APPROVALS DRAWN R.M. Bradley CHECKED ISSUED	DATE 4/16/2013		
NEXT ASSEMBLY	USED ON	SIZE B	FSCM NO. 60563	DWG. NO. PTRP10W105	REV. A
APPLICATIONS		DO NOT SCALE DRAWING		SCALE 2 X 1	SHEET 1 OF 1

SPECIFICATIONS:

1.) **MATERIALS:**
 INSERTS: VALOX, TYPE GPT-30F, PER MIL-M-24519.
 SHELLS: COLD ROLLED STEEL, PER ASTM A568 AND ASTM A620.

2.) **FINISHES AND COLOR:**
 INSERT: BLACK.
 SHELLS: RoHS COMPLIANT, HIGH RESISTANCE CLEAR CHROMATE OVER ZINC, PER ASTM B633, CLASS FE/ZN12 (.000500 MIN.), SERVICE CONDITION SC3, TYPE III.

3.) **ELECTRICAL PROPERTIES:**
 DIELECTRIC STRENGTH:
 500 TO 1,000 VOLTS RMS AT SEA LEVEL;
 200 TO 325 VOLTS RMS AT 70,000 FEET.
 INSULATION RESISTANCE: 1 MEGOHM MINIMUM.

4.) **MECHANICAL PROPERTIES:**
 OPERATING TEMPERATURE: -67° F TO +257° F (-55° C TO +125° C).
 SHOCK RESISTANCE: NO INTERRUPTION OF ELECTRICAL CONTINUITY LONGER THAN 1 MICROSECOND.
 VIBRATION RESISTANCE: NO INTERRUPTION OF ELECTRICAL CONTINUITY LONGER THAN 1 MICROSECOND.

5.) DIMENSIONS ARE FOR REFERENCE ONLY, UNLESS OTHERWISE SPECIFIED.

6.) CONNECTOR MEETS REQUIREMENTS OF MIL-C-24308, LATEST REVISION.

7.) ABOVE REQUIREMENTS DO NOT INCLUDE PDM AND PKZ CONTACTS, PLEASE SEE INDIVIDUAL SPECIFICATION SHEETS.

8.) METRIC DIMENSIONS ARE SHOWN FOR REFERENCE, CONNECTORS ARE DESIGNED IN INCHES.

REV	DESCRIPTION	DATE	APPROVAL
A	ECN#11740 RELEASED FOR PRODUCTION	7/26/2013	

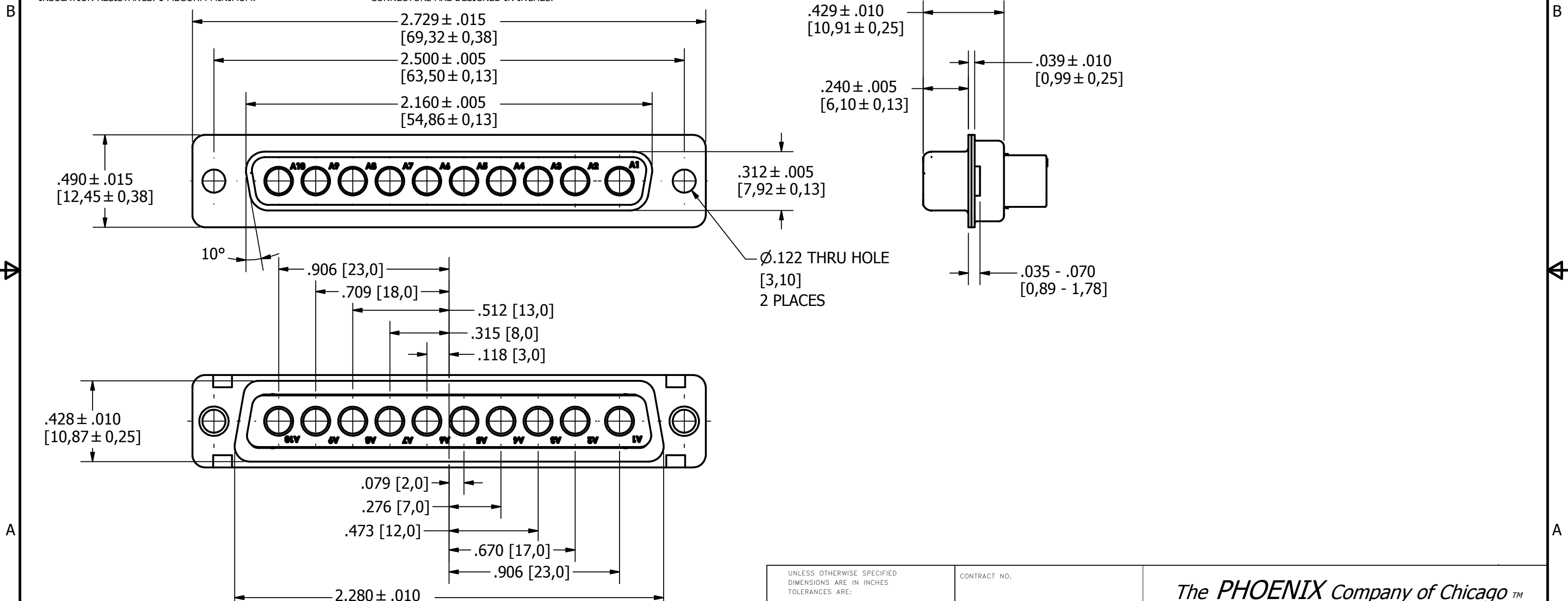

NEXT ASSEMBLY	USED ON
APPLICATIONS	DO NOT SCALE DRAWING

UNLESS OTHERWISE SPECIFIED DIMENSIONS ARE IN INCHES TOLERANCES ARE: FRACTIONS DECIMALS ANGLES ± 1/64 .XX ± .01 ± 1/2° .XXX ± .003		CONTRACT NO.		The <i>PHOENIX</i> Company of Chicago™	
THE INFORMATION DISCLOSED IN THIS DOCUMENT IS CONFIDENTIAL AND PROPRIETARY TO PHOENIX CO. INC. AND MAY NOT BE USED FOR MANUFACTURE OR ANY OTHER PURPOSE WITHOUT THE WRITTEN CONSENT OF MIL-CON INC.		APPROVALS	DATE		
		R.M. Bradley	4/16/2013	HD, D-SUB CONNECTOR, SIZE 12 PTRR10W105 RECEPTACLE, CLRCROM / ZINC	
		CHECKED			
		ISSUED		SIZE	FSCM NO.
				B	60563
				DWG. NO.	REV.
				PTRR10W105	A
				SCALE	SHEET 1 OF 1
				2 X 1	

4

3

2

1

SPECIFICATIONS:

1.) MATERIALS:
 INSERTS: VALOX, TYPE GPT-30F, PER MIL-M-24519.
 SHELLS: COLD ROLLED STEEL, PER ASTM A568 AND ASTM A620.

2.) FINISHES AND COLOR:
 INSERT: BLACK.
 SHELLS: RoHS COMPLIANT, HIGH RESISTANCE CLEAR CHROMATE OVER ZINC, PER ASTM B633, CLASS FE/ZN12 (.000500 MIN.), SERVICE CONDITION SC3, TYPE III.

3.) ELECTRICAL PROPERTIES:
 DIELECTRIC STRENGTH:
 500 TO 1,000 VOLTS RMS AT SEA LEVEL;
 200 TO 325 VOLTS RMS AT 70,000 FEET.
 INSULATION RESISTANCE: 1 MEGOHM MINIMUM.

4.) MECHANICAL PROPERTIES:
 OPERATING TEMPERATURE: -67° F TO +257° F (-55° C TO +125° C).
 SHOCK RESISTANCE: NO INTERRUPTION OF ELECTRICAL CONTINUITY LONGER THAN 1 MICROSECOND.
 VIBRATION RESISTANCE: NO INTERRUPTION OF ELECTRICAL CONTINUITY LONGER THAN 1 MICROSECOND.

5.) DIMENSIONS ARE FOR REFERENCE ONLY, UNLESS OTHERWISE SPECIFIED.

6.) CONNECTOR MEETS REQUIREMENTS OF MIL-C-24308, LATEST REVISION.

7.) ABOVE REQUIREMENTS DO NOT INCLUDE PDM AND PKZ CONTACTS, PLEASE SEE INDIVIDUAL SPECIFICATION SHEETS.

8.) METRIC DIMENSIONS ARE SHOWN FOR REFERENCE, CONNECTORS ARE DESIGNED IN INCHES.

REV	DESCRIPTION	DATE	APPROVAL
A	ECN#11740 RELEASED FOR PRODUCTION	7/26/2013	

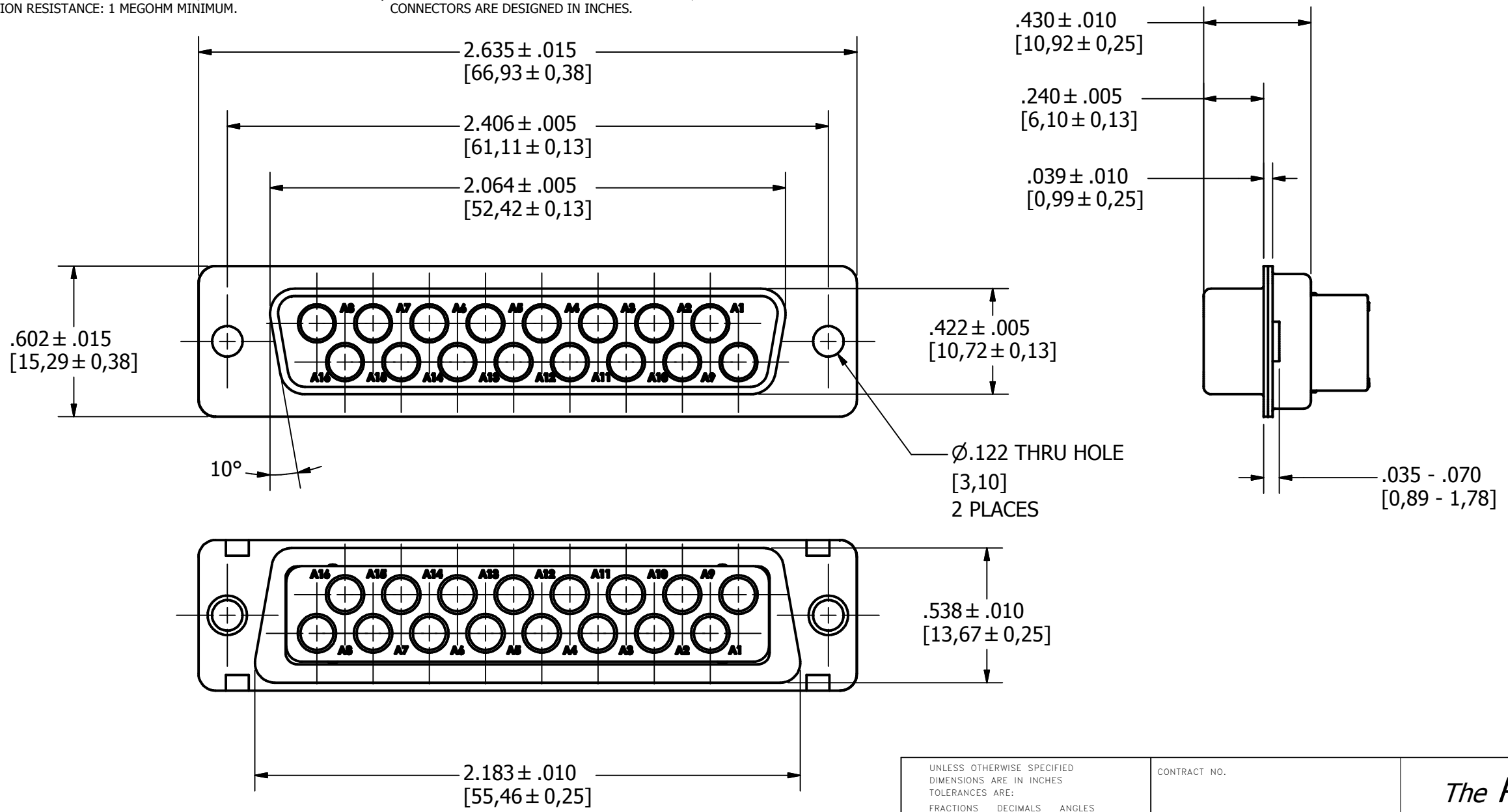

APPROVALS	DATE
R.M. Bradley	4/19/2013
CHECKED	
ISSUED	

UNLESS OTHERWISE SPECIFIED DIMENSIONS ARE IN INCHES TOLERANCES ARE: FRACTIONS DECIMALS ANGLES ± 1/64 .XX ± .01 ± 1/2° .XXX ± .003	CONTRACT NO.
THE INFORMATION DISCLOSED IN THIS DOCUMENT IS CONFIDENTIAL AND PROPRIETARY TO PHOENIX CO. INC. AND MAY NOT BE USED FOR MANUFACTURE OR ANY OTHER PURPOSE WITHOUT THE WRITTEN CONSENT OF MIL-CON INC.	APPROVALS
DO NOT SCALE DRAWING	DATE

<i>The PHOENIX Company of Chicago™</i>			
HD, D-SUB CONNECTOR, SIZE 12 PTRR16W165, RECEPTACLE, CLRCROM / ZINC			
SIZE	FSCM NO.	DWG. NO.	REV.
B	60563	PTRR16W165	A
SCALE	2 X 1		SHEET 1 OF 1

4

3

2

1